

Tradesmig 171/201 ***Tradesmig 251***

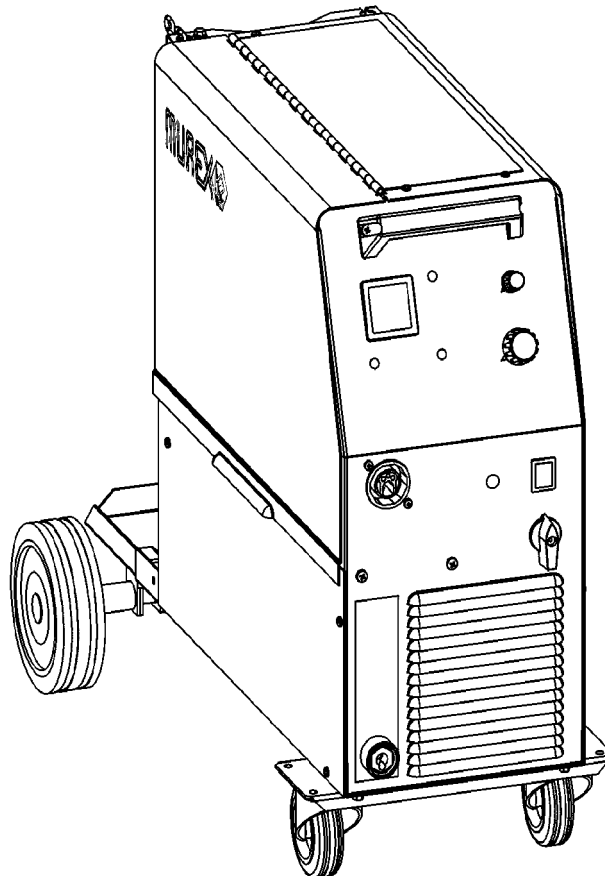

Instruction manual



DECLARATION OF CONFORMITY

Murex Welding Products Ltd.

Declare hereby that:

Murex Tradesmig 171/201/251

Part No. 0349 311 660, 0349 311 650, 0349 311 640

Manufactured after 1st May 2005

- conform with the requirements of Council Directive 72/23/EEC, amended by Council Directive 93/68/EEC, relating to electrical equipment designed for use within certain voltage limits.
- conform with the requirements of Council Directive 89/336/EEC, amended by Council Directive 93/68/EEC, relating to electromagnetic compatibility.
- are manufactured in accordance with EN60974-1 Safety Requirements for Arc Welding Equipment.
- are manufactured in accordance with EN60974-10 Electromagnetic Compatibility for Arc Welding Equipment.

On behalf of Murex Welding Products Ltd. Hanover House, Queensgate Britannia Road, Waltham Cross Herts. EN8 7TF England	
	Kent Eimbrodt Global Director Equipment and Automation

Manufactured by Esab Welding Equipment AB.

1 SAFETY	4
2 INTRODUCTION	6
2.1 Equipment	6
3 TECHNICAL DATA	6
4 INSTALLATION	8
4.1 Placing	8
4.2 Assembly of components	8
4.3 Electrical installation	9
4.4 Mains power supply	9
5 OPERATION	10
5.1 Connection and control devices	10
5.2 Functions explanation	11
6 MAINTENANCE	11
6.1 Inspection and cleaning	11
7 FAULT TRACING	12
DIAGRAM	13
WEAR COMPONENTS	20
ACCESSORIES	21

Rights reserved to alter specifications without notice.

1 SAFETY

Users of welding equipment have the ultimate responsibility for ensuring that anyone who works on or near the equipment observes all the relevant safety precautions. Safety precautions must meet the requirements that apply to this type of welding equipment. The following recommendations should be observed in addition to the standard regulations that apply to the workplace.

All work must be carried out by trained personnel well-acquainted with the operation of the welding equipment. Incorrect operation of the equipment may lead to hazardous situations which can result in injury to the operator and damage to the equipment.

1. Anyone who uses the welding equipment must be familiar with:
 - its operation
 - location of emergency stops
 - its function
 - relevant safety precautions
 - welding
2. The operator must ensure that:
 - no unauthorised person is stationed within the working area of the equipment when it is started up.
 - no-one is unprotected when the arc is struck
3. The workplace must:
 - be suitable for the purpose
 - be free from draughts
4. Personal safety equipment
 - Always wear recommended personal safety equipment, such as safety glasses, flame-proof clothing, safety gloves.
 - Do not wear loose-fitting items, such as scarves, bracelets, rings, etc., which could become trapped or cause burns.
5. General precautions
 - Make sure the return cable is connected securely.
 - Work on high voltage equipment **may only be carried out by a qualified electrician.**
 - Appropriate fire extinguishing equipment must be clearly marked and close at hand.
 - Lubrication and maintenance must **not** be carried out on the equipment during operation.



WARNING



ARC WELDING AND CUTTING CAN BE INJURIOUS TO YOURSELF AND OTHERS. TAKE PRECAUTIONS WHEN WELDING. ASK FOR YOUR EMPLOYER'S SAFETY PRACTICES WHICH SHOULD BE BASED ON MANUFACTURERS' HAZARD DATA.

ELECTRIC SHOCK - Can kill

- Install and earth the welding unit in accordance with applicable standards.
- Do not touch live electrical parts or electrodes with bare skin, wet gloves or wet clothing.
- Insulate yourself from earth and the workpiece.
- Ensure your working stance is safe.

FUMES AND GASES - Can be dangerous to health

- Keep your head out of the fumes.
- Use ventilation, extraction at the arc, or both, to take fumes and gases away from your breathing zone and the general area.

ARC RAYS - Can injure eyes and burn skin.

- Protect your eyes and body. Use the correct welding screen and filter lens and wear protective clothing.
- Protect bystanders with suitable screens or curtains.

FIRE HAZARD

- Sparks (spatter) can cause fire. Make sure therefore that there are no inflammable materials nearby.

NOISE - Excessive noise can damage hearing

- Protect your ears. Use earmuffs or other hearing protection.
- Warn bystanders of the risk.

MALFUNCTION - Call for expert assistance in the event of malfunction.

READ AND UNDERSTAND THE INSTRUCTION MANUAL BEFORE INSTALLING OR OPERATING.

PROTECT YOURSELF AND OTHERS!

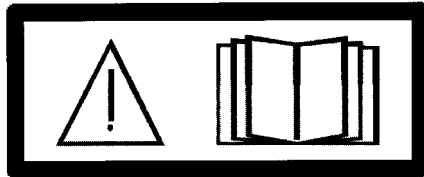

WARNING!

Read and understand the instruction manual before installing or operating.



WARNING!

Do not use the power source for thawing frozen pipes.



This product is solely intended for arc welding.

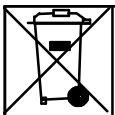

Do not dispose of electrical equipment together with normal waste!

In observance of European Directive 2002/96/EC on Waste Electrical and Electronic Equipment and its implementation in accordance with national law, electrical equipment that has reached the end of its life must be collected separately and returned to an environmentally compatible recycling facility. As the owner of the equipment, you should get information on approved collection systems from our local representative.

By applying this European Directive you will improve the environment and human health!

2 INTRODUCTION

Tradesmig 171/201/251 are step controlled power sources in a compact design, intended for welding with solid steel, stainless steel or aluminium wire as well as tubular wire with or without shielding gas.

2.1 Equipment

The power source is supplied with:

- Return cable 3m with return clamp
- Shelf for gas cylinder
- Instruction manual

3 TECHNICAL DATA

	Tradesmig 171
Voltage	230-240V, 1~ 50/60Hz
Permissible load at 100% duty cycle	76A/17,8V
60 % duty cycle	98A/18,9V
25 % duty cycle	155A/21,7V
20 % duty cycle	170A/21,0V
Setting range (DC)	30A/15,5V-155A/21,7V (170A/21,0)
Open circuit voltage	22,4-44,5V
Open circuit power	270W
Power factor at max load	0,91
Control voltage	42V, 50/60Hz
Wire feed speed	1,0-17m/min
Burnback time	0,02-0,25s
Spot welding	0,2-2,5s
Welding gun connection	EURO
Wire dimension range	0,6-0,8(Fe) 1,0(Al) 0,8(cored) 0,8-1,0(CuSi)
Max diameter/weight of wire bobin	300mm/15kg
Dimensions lxxh	860x420x730
Weight	62kg
Operating temperature	-10 ÷ +40°C
Enclosure class	IP 23
Application classification	S

	Tradesmig 201	Tradesmig 251
Voltage	230-240V, 1~ 50/60Hz	230-240V, 1~ 50/60Hz
Permissible load at 100% duty cycle	90A/18,5V	110A/19,5V
60 % duty cycle	115A/19,7V	140A/21,0V
@ % duty cycle	185A/23,3V @ 23%	200A/24,0V @ 30%
20 % duty cycle	200A/23,0V	250A/21,0V
Setting range (DC)	30A/15,5V-185A/23,3V (200A/23,0V)	40A/16,0V-200A/24,0V (250A/21,0V)
Open circuit voltage	19,6-44,9V	19,0-41,5V
Open circuit power	120W	200W
Power factor at max load	0,89	0,92
Control voltage	42V, 50/60Hz	42V, 50/60Hz
Wire feed speed	1,0-17m/min	1,9-19m/min
Burnback time	0,02-0,25s	0-0,25s
Spot welding	0,2-2,5s	0,2-2,5s
Welding gun connection	EURO	EURO
Wire dimension range	0,6-1,0(Fe) 1,0(Al) 0,8-1,0(cored) 0,8-1,0(CuSi)	0,6-1,2(Fe) 1,0-1,2(Al) 0,8-1,2(cored) 0,8-1,0(CuSi)
Max diameter/weight of wire bobin	300mm/15kg	300mm/15kg
Dimensions lxxh	860x420x730	860x420x730
Weight	70kg	92kg
Operating temperature	-10 ÷ +40°C	-10 ÷ +40°C
Enclosure class	IP 23	IP 23
Application classification	S	S

Duty cycle

The duty cycle refers to the time as a percentage of a ten-minute period that you can weld at a certain load without overloading.

Enclosure class

The **IP** code indicates the enclosure class, i. e. the degree of protection against penetration by solid objects or water. Equipment marked **IP23** is designed for indoor and outdoor use.

Application class

The symbol **S** indicates that the power source is designed for use in areas with increased electrical hazard.

4 INSTALLATION

The installation must be executed by a professional.



WARNING!

This product is intended for industrial use. In a domestic environment this product may cause radio interference. It is the user's responsibility to take adequate precautions.

4.1 Placing

Position the welding power source such way that its cooling air inlets and outlets are not obstructed.

4.2 Assembly of components



WARNING!

For packing and shipment of the machine the wheels are detached from the unit. Before use attach the wheels according to instruction.

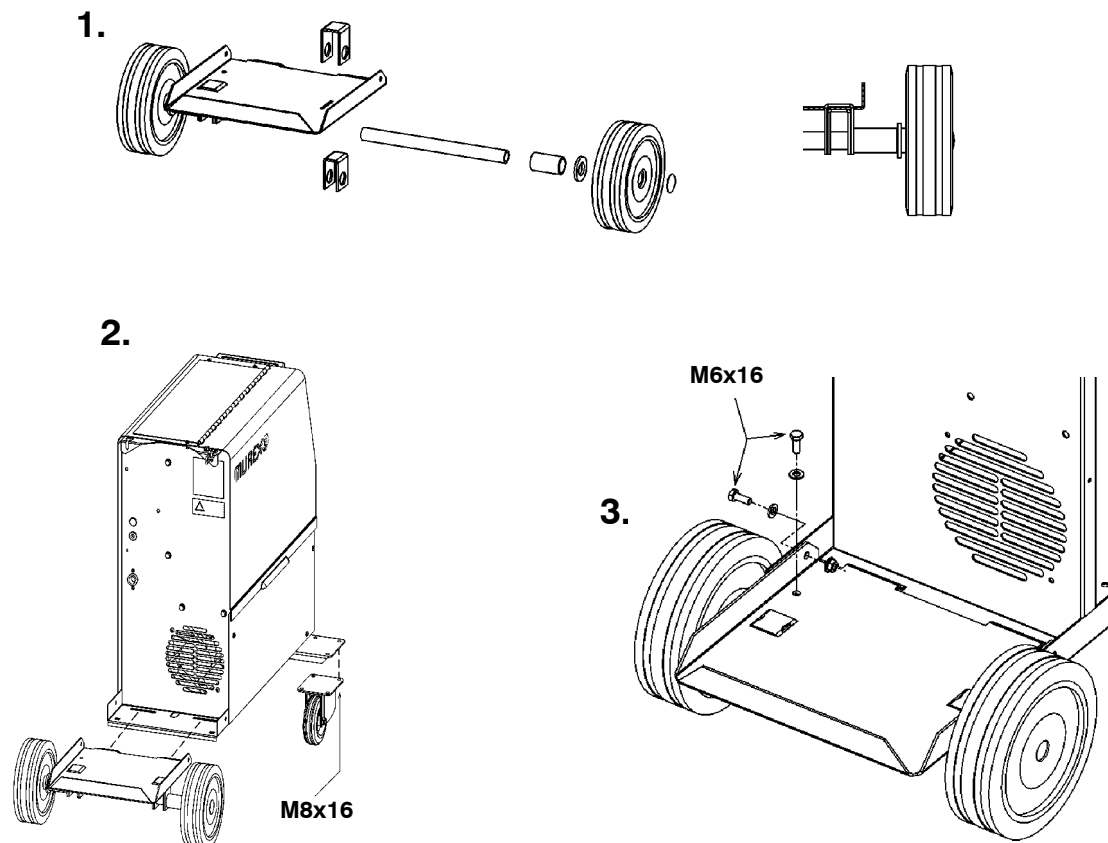

4.3 Electrical installation

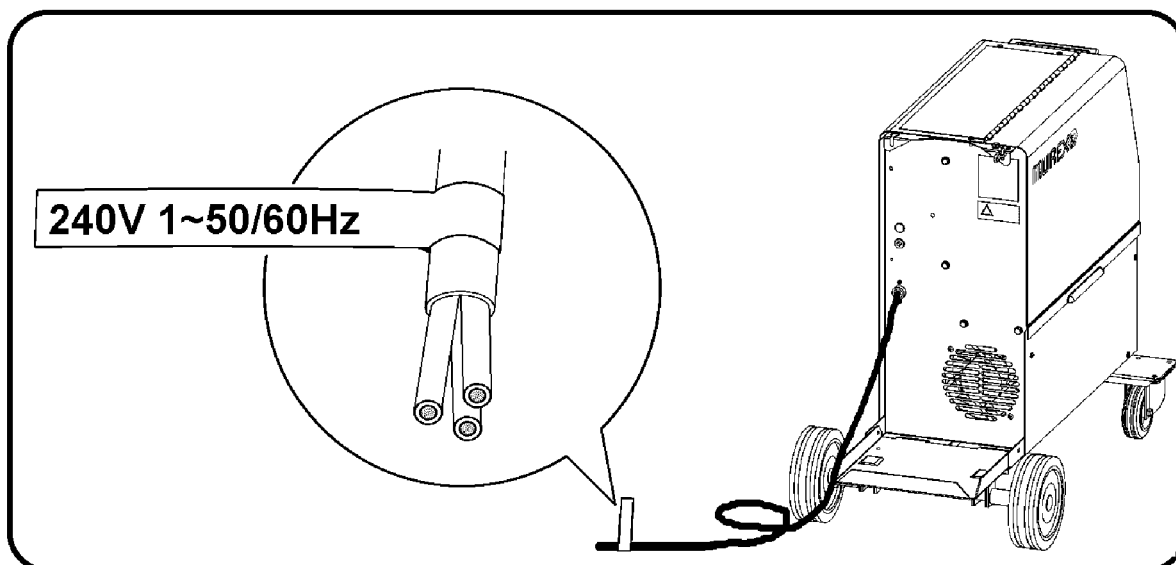

4.4 Mains power supply

Check that the unit is connected to the correct mains power supply voltage, and that it is protected by the correct fuse size. A protective earth connection must be made, in accordance with regulations.

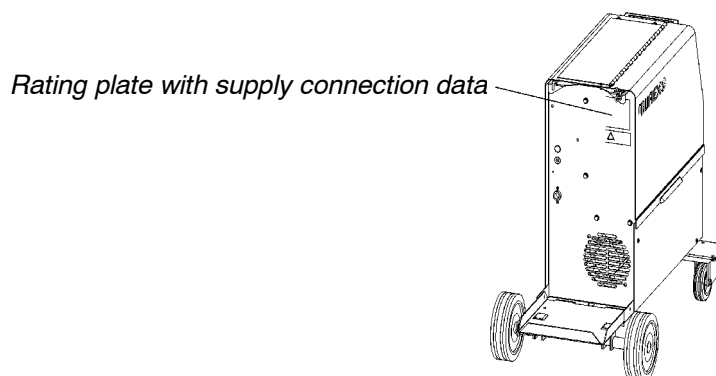

	Tradesmig 171	Tradesmig 201	Tradesmig 251
Voltage V	220-230V, 1~ 50/60Hz	220-230V, 1~ 50/60Hz	220-230V, 1~ 50/60Hz
Current A at 100% duty cycle	12,0	13,0	16,6
at 60% duty cycle	15,7	18,2	23,4
at @% duty cycle	27,8 @ 25%	36,2 @ 23%	38,7 @ 30%
at 20% duty cycle	29,7	39,0	47,5
Cable area mm²	3 x 1.5	3 x 2.5	3 x 4,0
Fuse slow A	16	20	35

5 OPERATION

General safety regulations for the handling of the equipment can be found on page 4. Read through before you start using the equipment!



WARNING!

Rotating parts can cause injury, take great care.



WARNING - TIPPING RISK!

There is a risk of tipping while transportation and operation, if the welding machine leans more than 10°. In that case appropriate securing has to be provided !

5.1 Connection and control devices

- | | | | |
|---|-----------------------------------------------------------------------------|---|---------------------------------------------------------------------------------------------------------------------------|
| 1 | Mains supply switch with indicating lamp | 6 | Knob for spot welding - ON/OFF and time setting |
| 2 | Orange indicating lamp, overheating | 7 | Knob for wire speed setting |
| 3 | Welding voltage switch
T171: 8 steps
T201: 12 steps
T251: 12 steps | 8 | Digital instrument - V/A,
(option, see page 21) |
| 4 | EURO - connector for welding gun | 9 | Knob for burn-back time setting.
In T251 located in wire feeder compartment,
in T171/T201 located on control board. |
| 5 | Connection for return cable (-) | | |

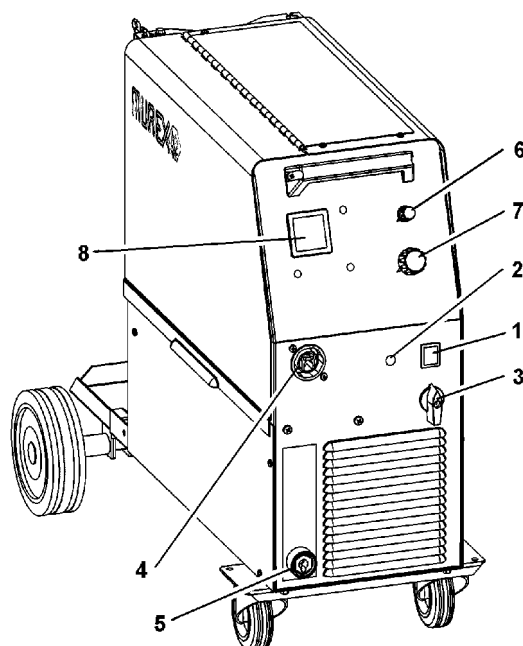

5.2 Functions explanation

5.2.1 Overheating protection

When the machine is switched on with the mains switch [1], indicating lamp [1] is on and lamp [2] off - the machine is ready to operate. If the internal temperature becomes too high, the welding is interrupted and disabled. This state is indicated by lighting of the orange indicating lamp [2] on the front of the machine. It resets automatically when the temperature has fallen.

6 MAINTENANCE

Regular maintenance is important for safe, reliable operation.

Note!

All guarantee undertakings from the supplier cease to apply if the customer himself attempts any work in the product during the guarantee period in order to rectify any faults.

6.1 Inspection and cleaning

Check regularly that the power source is free from dirt.

The power source should be regularly blown clean using dry compressed air at reduced pressure. More frequently in dirty environments. Otherwise the air inlet/outlet may become blocked and cause overheating.

Welding gun

- Cleaning and replacement of the welding gun's wear parts should take place at regular intervals in order to achieve trouble-free wire feed. Blow the wire guide clean regularly and clean the contact tip.

The brake hub

The hub is adjusted when delivered, if readjustment is required, follow the instructions below. Adjust the brake hub so that wire is slightly slack when wire feed stops.

- **Adjusting the braking torque:**

- Turn the red handle to the locked position.
- Insert a screwdriver into the springs in the hub.

Turn the springs clockwise to reduce the braking torque

Turn the springs anticlockwise to increase the braking torque. **NB:** Turn both springs through the same amount.

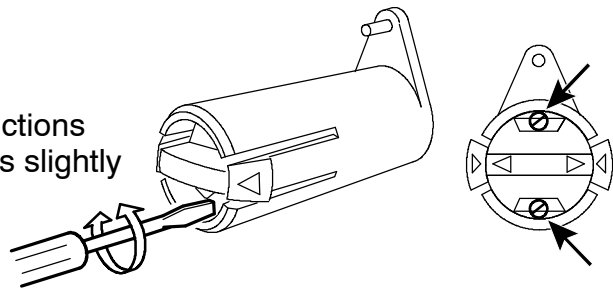

7 FAULT TRACING

Try these recommended checks and inspections before sending for an authorised service technician.

Type of fault	Actions
No arc	<ul style="list-style-type: none">• Check that the mains power supply switch is turned on.• Check that the welding current supply and return cables are correctly connected.• Check that correct current value is set.
Welding current is interrupted during welding	<ul style="list-style-type: none">• Check whether the thermal overload trip has operated (indicated by the orange lamp on the front).• Check the main power supply fuses.
Thermal overload trips operate frequently	<ul style="list-style-type: none">• Check to see whether the air inlets/outlets are clogged.• Make sure that you are not exceeding the rated data for the power source (i.e. that the unit is not being overloaded).
Poor welding performance	<ul style="list-style-type: none">• Check that the welding current supply and return cables are correctly connected.• Check that the correct current value is set.• Check that the correct welding wires are being used.• Check the main power supply fuses.• Check the wire feed unit – if proper rolls are applied and properly set the pressure of the wire feeder's pressure rollers

Tradesmig 171/201/251 is designed and tested in accordance with the international and European standards IEC/EN 60974-1 and EN 60974-10. It is the obligation of the service unit which has carried out the service or repair work to make sure that the product still conforms to the said standard.

Diagram

Tradesmig 171, 240V (valid until June 2008)

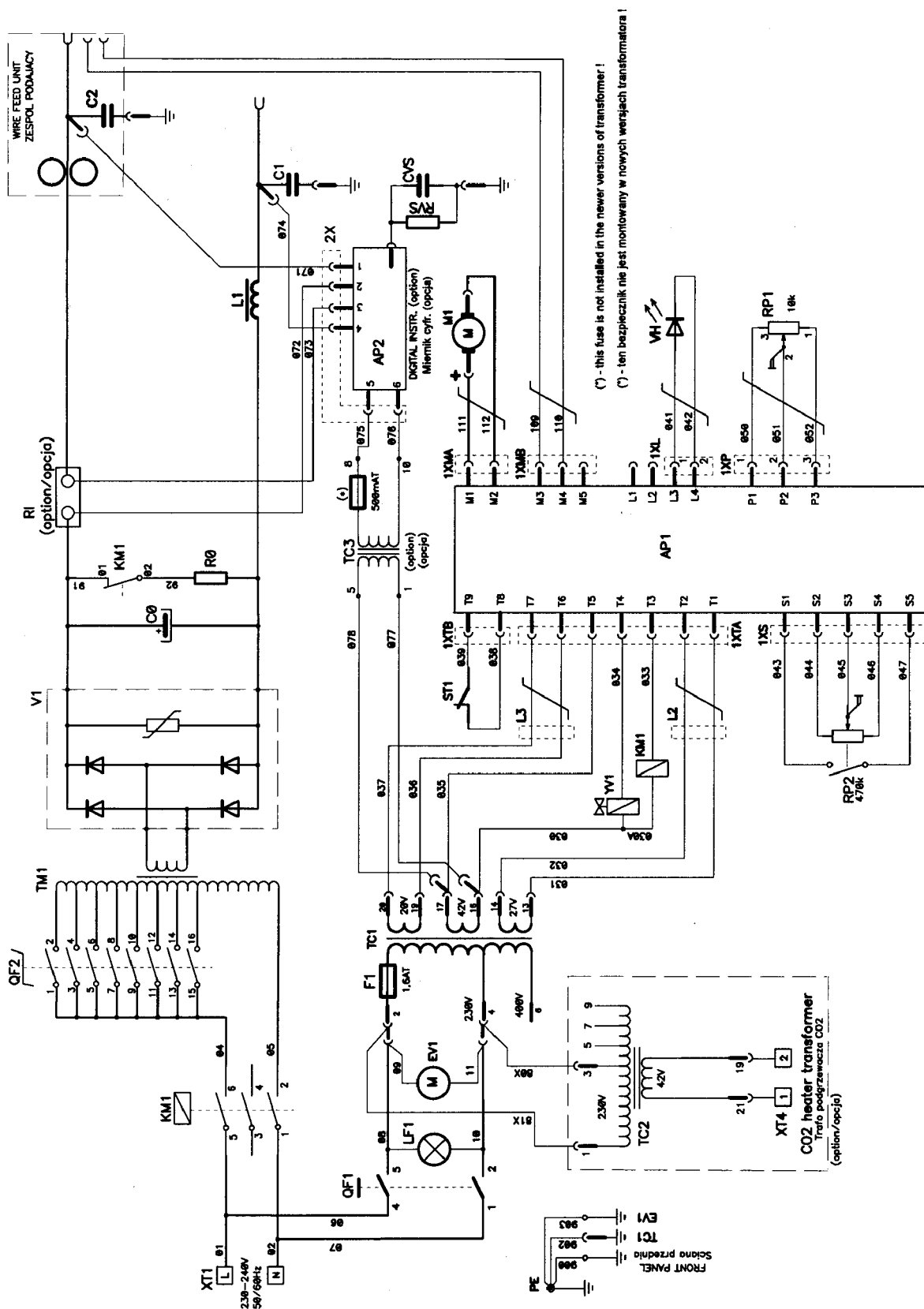

Tradesmig 171, 240V (valid from July 2008)

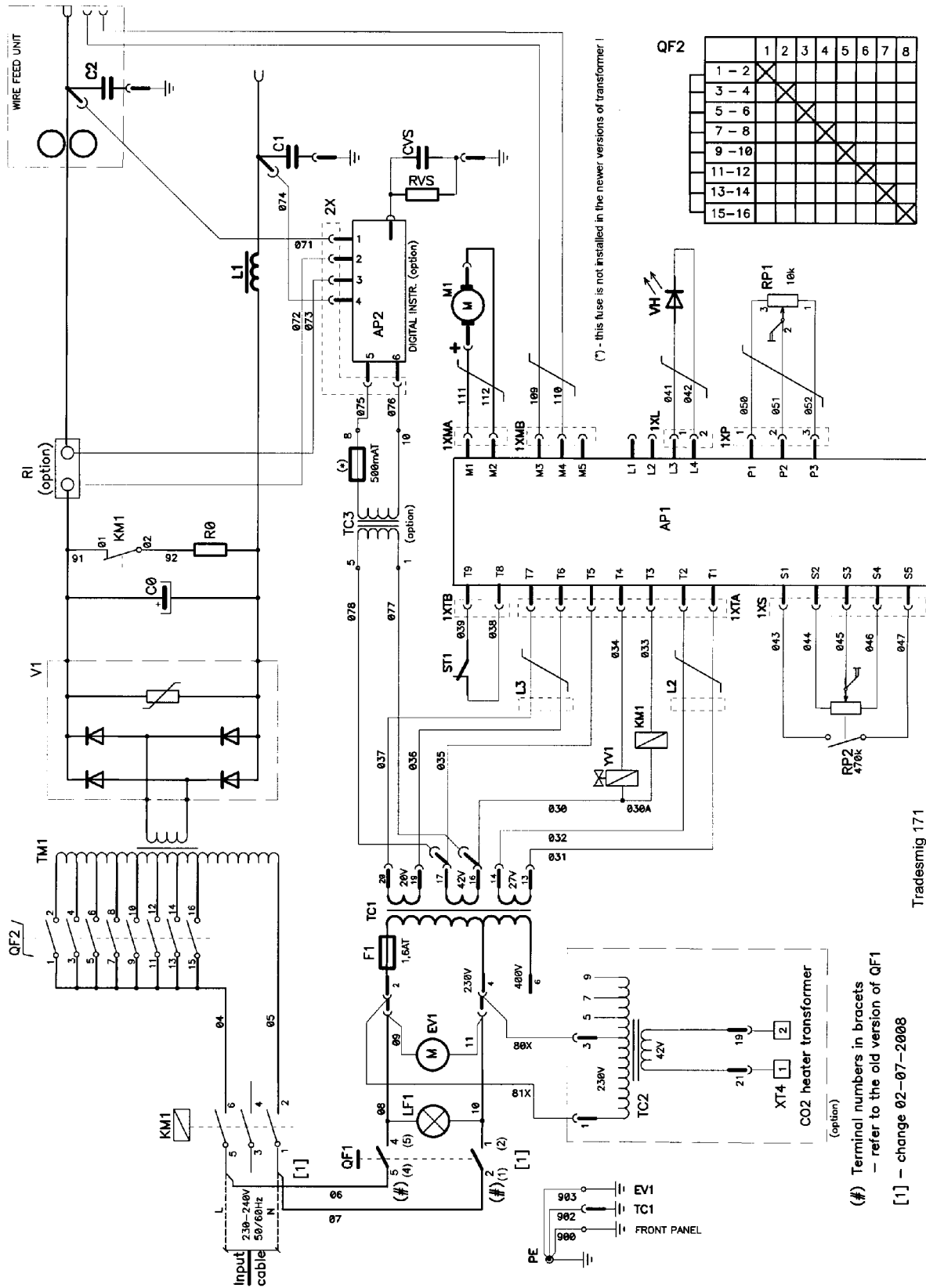

QF2

	1	2	3	4	5	6	7	8
1	2							
3	4							
5	6							
7	8							
9	10							
11	12							
13	14							
15	16							

Tradesmig 171

(#) Terminal numbers in brackets
 - refer to the old version of QF1
 [1] - change 02-07-2008

Tradesmig 201, 240V (valid from July 2008)

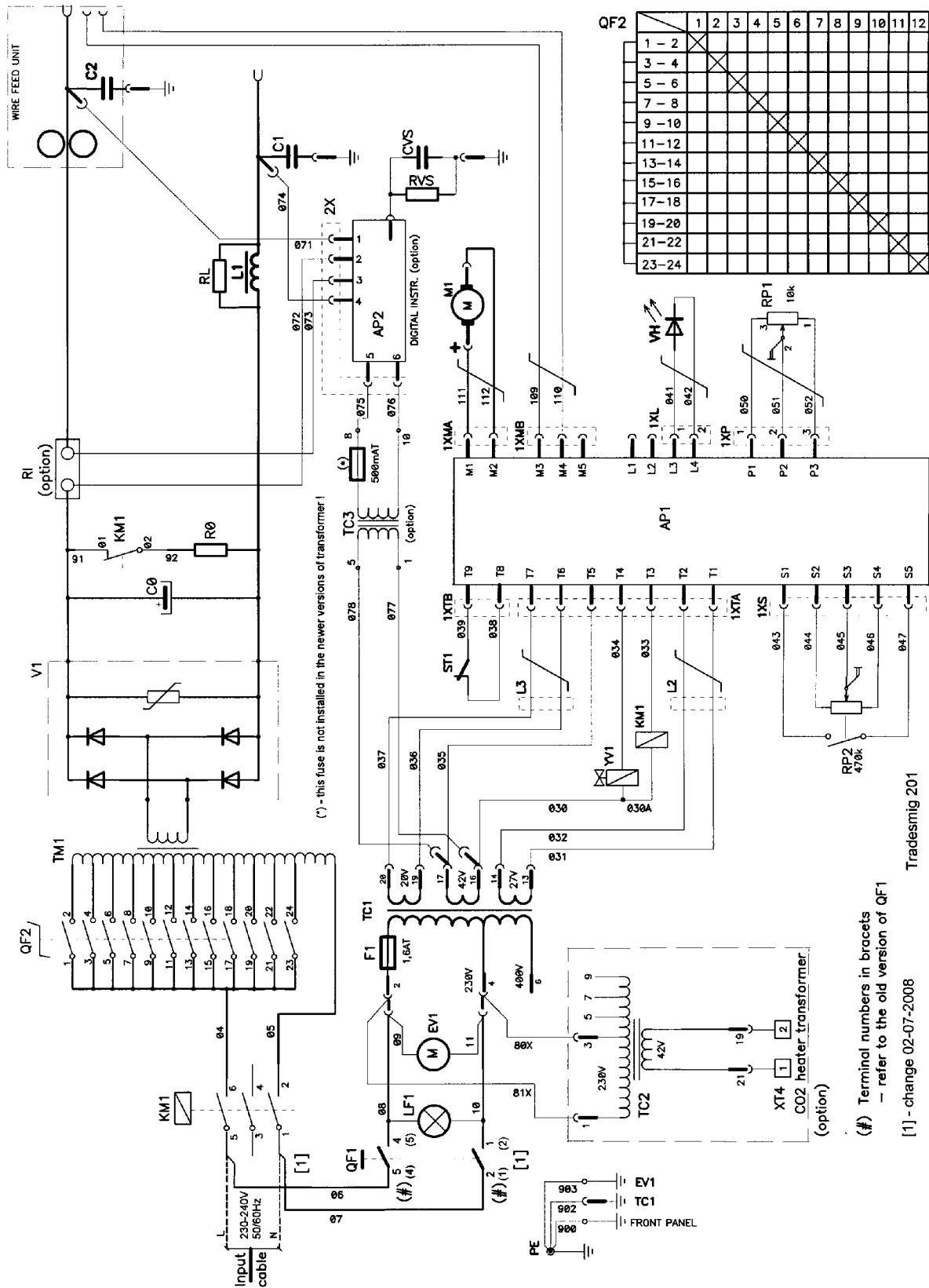

QF2		1	2	3	4	5	6	7	8	9	10	11	12
1	2												
3	4												
5	6												
7	8												
9	10												
11	12												
13	14												
15	16												
17	18												
19	20												
21	22												
23	24												

Tradesmig 201

Tradesmig 251, 240V (valid untill June 2008)

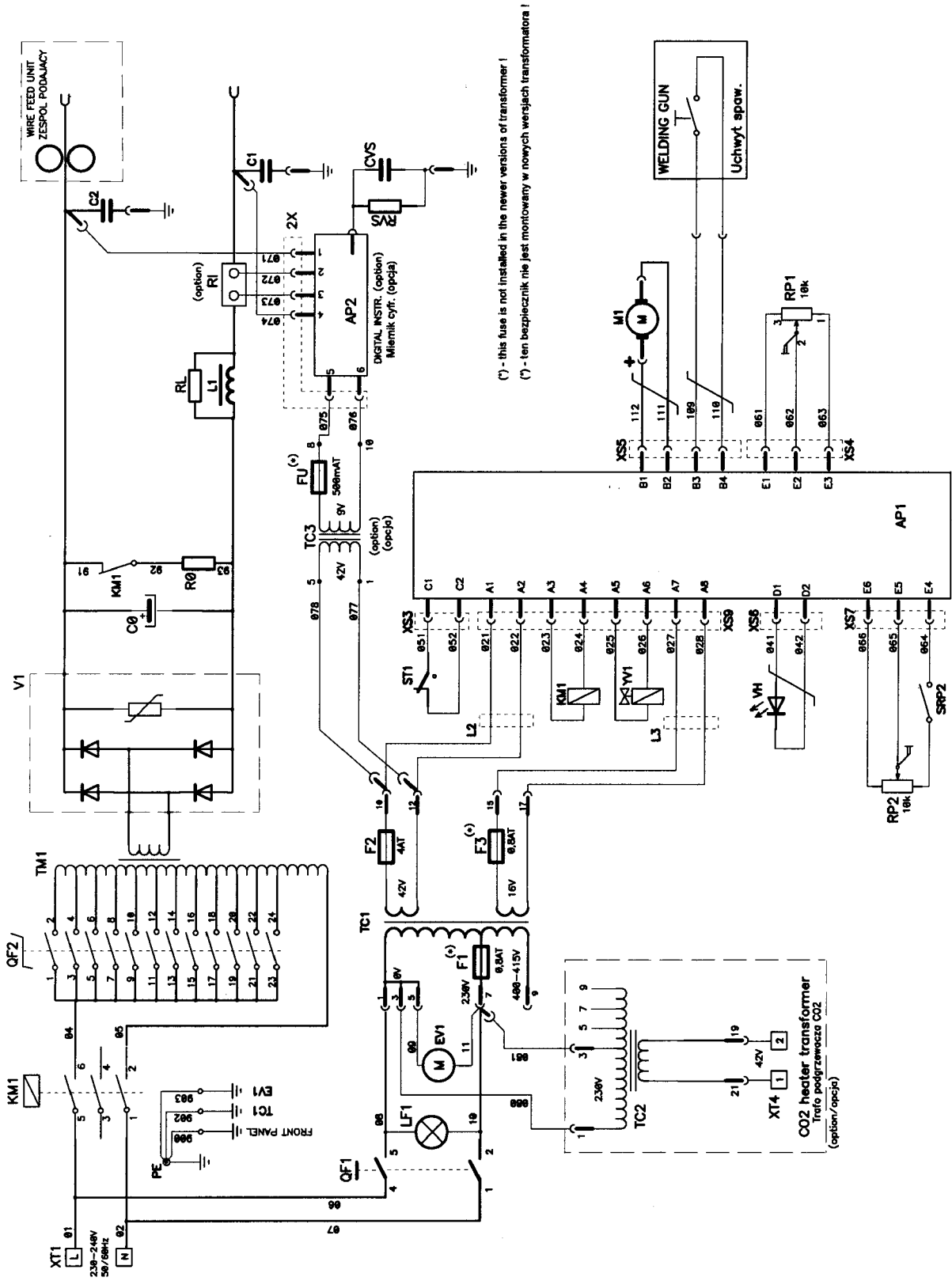

(*) - this fuse is not installed in the newer versions of transformer !
 (*) - ten bezpiecznik nie jest montowany w nowych wersjach transformatora !

Tradesmig 251, 240V (valid from July 2008)

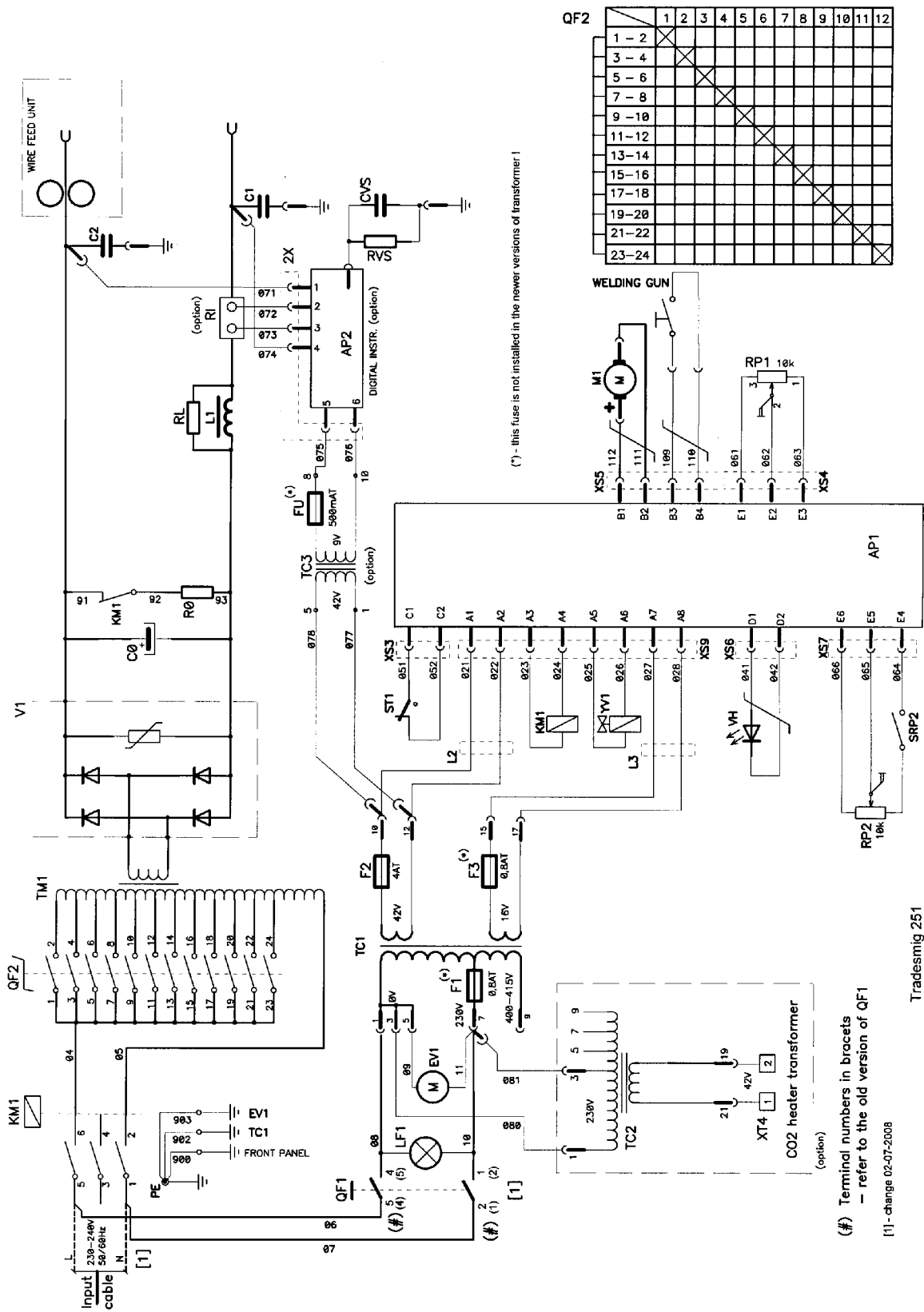

(*) - this fuse is not installed in the newer versions of transformer 1

QF2

	1	2	3	4	5	6	7	8	9	10	11	12
1-2		X										
3-4			X									
5-6				X								
7-8					X							
9-10						X						
11-12							X					
13-14								X				
15-16									X			
17-18										X		
19-20											X	
21-22												X
23-24												

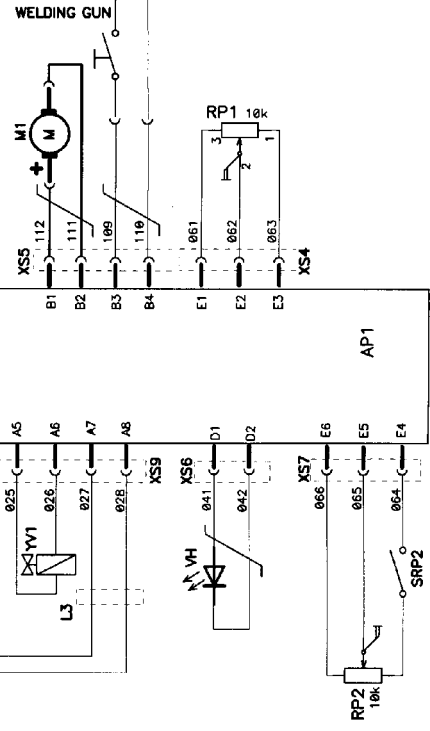

(#) Terminal numbers in brackets
 - refer to the old version of QF1

[1] - change 02-07-2008

Tradesmig 251

Tradesmig 171/201/251

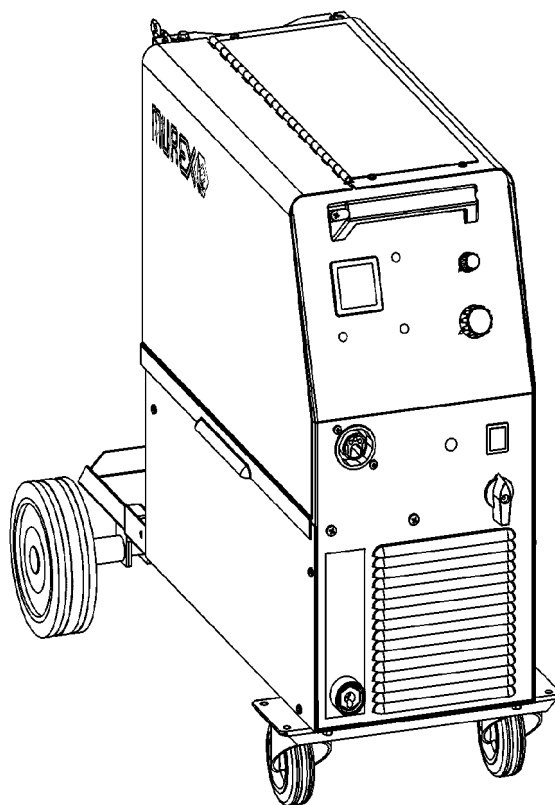

Valid for serial no. 811-XXX-XXXX

Ordering numbers

0349 311 660	Tradesmig 171	240V 1~50/60Hz
0349 311 650	Tradesmig 201	240V 1~50/60Hz
0349 311 640	Tradesmig 251	240V 1~50/60Hz

Wear components

(W. F. Mechanism 0455 890 890 / 0455 890 882)

Item	Denomination	Ordering no.	Notes
A	Pressure roller	0455 907 001	
B	Feed roller	0367 556 001	Ø 0.6-0.8mm Fe, Ss, cored wire.
		0367 556 002	Ø 0.8-1.0mm Fe, Ss, cored wire.
		0367 556 003	Ø 1.0-1.2mm Fe, Ss, cored wire.
		0367 556 004	Ø 1.0-1.2mm Al wire.
C	Inlet nozzle	0466 074 001	
D	Insert tube	0455 894 001	Plastic, must be used together with item 0455 885 001, for welding with Al wire.
		0455 889 001	Steel, must be used together with item 0455 886 001.
E	Outlet nozzle	0455 885 001	Must be used together with item 0455 894 001, for welding with Al wire.
		0455 886 001	Must be used together with item 0455 889 001.

The rollers are marked with wire dimension in mm, some are also marked with inch.

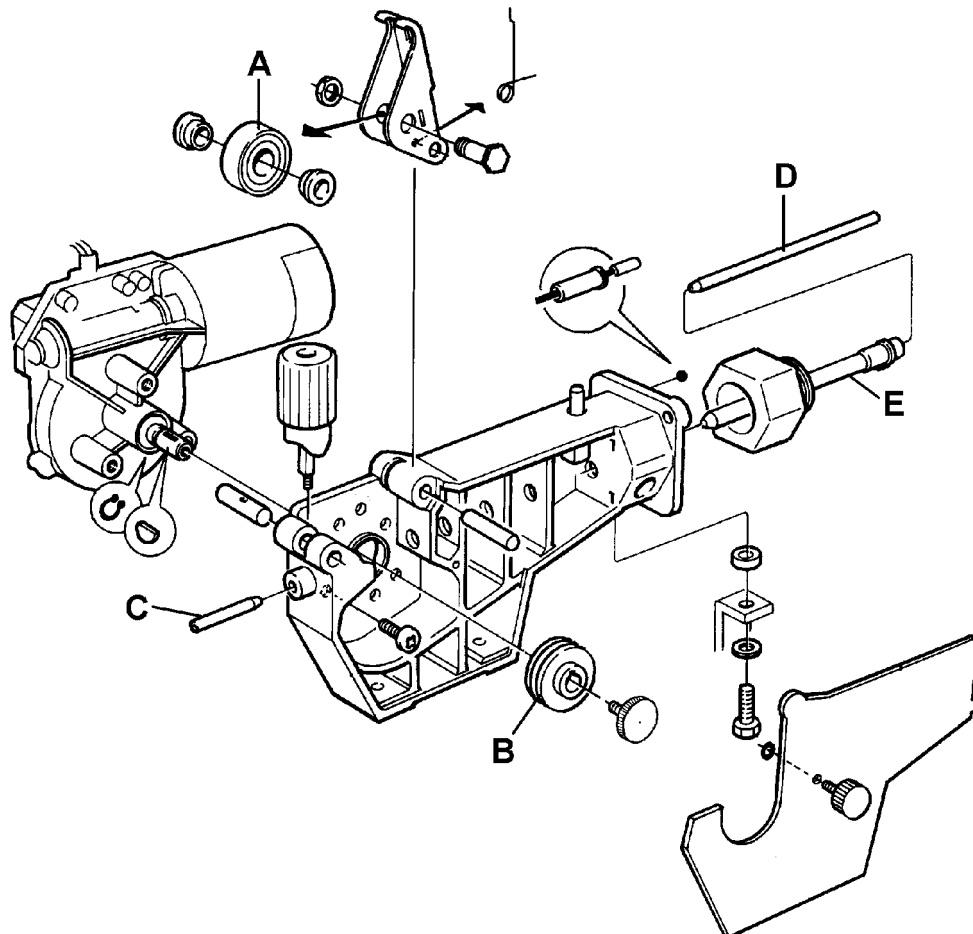







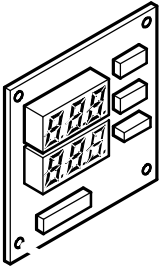
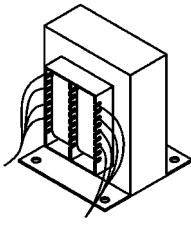

























































Welding with aluminium wires.











In order to weld with aluminium wires, proper rollers, nozzles and liners for aluminium wires **MUST** be used. It is recommended to use 3m long welding gun for aluminium wires, equipped with appropriate wear parts.

Accessories

 A technical drawing of a digital meter. It features a rectangular faceplate with a central digital display showing the number '1234'. To the right of the display are several indicator lights and a small dial. Below the display are two rows of terminals for wiring. The entire unit is mounted on a metal plate with four screws.	<p>Digital meter 0349 308 400</p>
 A technical drawing of a transformer kit. It consists of a rectangular metal housing with a central vertical core. Two primary windings are visible on the left side of the core, and two secondary windings are on the right. Wires extend from the bottom of the unit. The housing is mounted on a base plate with four screws.	<p>Transformer kit for CO₂ heater 0349 308 890</p>

T171		d [mm]	Fe Ar+18%CO2		Fe CO2		SS Ar+2%CO2		AlMg5 Ar 100%		CuSi3 Ar+1%O2									
				1-8		1-10		1-8		1-10		1-8		1-10						
	0,6	0,6		1		1-10		3		1-10		1-8								
				2		2		1												
				3		3		2												
				0,8		0,8				2			3		3,5		2		5	2
										3			4		3		3,5		2	
										3			4		3		3,5		1	
				1,0		1,0				3			4		4,5		3		5,5	3
										3			4		4		4,5		3	
										4			5		4		4,5		4	
										4			5		4		4,5		4	
				1,5		1,5				4			5		5,5		4		6,5	3
										4			5		5		5,5		5	
5	6	5	5,5		5															
5	6	5	5,5		5															
2,0	2,0		6		7		7,5		6		8,5	2								
			6		7		6		6,5		6									
			7		8		6		6,5		6									
			7		8		6		6,5		6									
3,0	3,0		8		9		9,5		7		10,5	3								
			8		9		7		7,5		7									
			9		10		7		7,5		7									
			9		10		7		7,5		7									
4,0	4,0		8		9		9,5		8		10,5	8								
			8		9		8		8,5		8									
			9		10		8		8,5		8									
			9		10		8		8,5		8									
	0,6	0,6		6		5		8		6		7								
				5		5		5												
				4		4		5												
				0,8		0,8				7			6		8		7		8	6
										6			6		6		6,5		6	
										6			6		6		6,5		6	
				1,0		1,0				5			5		5,5		6		6,5	7
										5			5		5		5,5		5	
										6			6		5		5,5		5	
										6			6		5		5,5		5	
				1,5		1,5				8			7		7,5		8		8,5	8
										7			7		7		7,5		7	
7	7	7	7,5		7															
7	7	7	7,5		7															

171
GIN: 0349 311 649

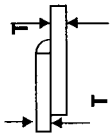
T201		d [mm]	Fe Ar+18%CO2		Fe CO2		SS Ar+2%CO2		AlMg5 Ar 100%		CuSi3 Ar+1%O2				
															
	0,6	0,6	1	2,8	3	3	3,5	2	3,5	1-10	1-12	1-10	1-12		
			2	2,5	2,3	4	3	2	3,5	1					
			0,8	2	3	3,5	4	3	4	3	3,5				
				3	2,7	2,8	5	3,6	3	3	4	4	2		
				3	2,4	2,4	5	3	4	4	3,1	2			
			1,0	3	3,5	4	5	5,5	4	4	4,5	3			
				4	3	3	6	4	4	4	4,5	1			
				4	2,5	2,6	6	3,5	5	5	4				
			1,5	5	4,5	4,5	6	7	6	6	7				
				5	3,5	3,5	7	6	6	6	5,2	3			
				5	2,9	3	7	7	6	6	4				
			2,0	8	9	5	7	7	7	7	8,5				
7	5	4,5		8	8	8	8	8							
7	3,5	3,5		9	9	9	9	5	7	5					
3,0	12	10	8	9	9	10	10	10							
	9	6,5	5,5	10	10	10	10	6,5							
	9	4,5	4	10	10	10	10	5	8	8					
4,0	11	8,5	6	11	11	11	11	7							
	11	5,5	4,5	11	11	11	11	5	11	11					
	12	8,5	7	12	12	12	12	7,5							
5,0	12	6	5,5	12	12	12	12	5,5							
	12	9	5	7	6	6	6	9							
	12	5	4,5	8	5	5	5	4,5							
0,6	0,6	0,6	8	9	4	4	4	4	5	7	6				
			7	5	5	8	5	5	4,5	8	5				
			4	4	4	10	4	4	4	10	4				
0,8	0,8	0,8	8	9	5	6	5	6	6	10	6				
			9	6,5	5	9	6	6	5	9	6				
			10	4,5	4	10	5	5	4	10	5				
1,0	0,8	0,8	10	9	6	7,5	6	7	7,5	11	7				
			11	8,5	6	11	6	6	6	11	6				
			11	5	4,5	11	5	5	4,5	11	5				
1,5	0,6	0,6	12	7	7	7	7	7	7	12	7				
			12	8,5	5	12	5	5	5	12	5				
			12	6	6	12	5	5	6	12	5				

201
GIN: 0349 311 643

T251	T [mm]	d [mm]	Fe Ar+18%CO2		Fe CO2		SS Ar+2%CO2		AlMg5 Ar 100%		
			1-12	1-10	1-12	1-10	1-12	1-10	1-12	1-10	1-12
	0,6	0,6	3,0	1	3,5	3	3,5	1			
		0,8	2,0	1	2,1	3					
	0,8	0,6	4,0	2	4,0	4	3,5	2			
		0,8	2,6	2	2,5	4	2,5	1			
		1,0	2,0	1	2,0	3	2,0	1			
		1,2	1,8	2							
	1,0	0,6	4,5	3	4,5	5	4,0	3			
		0,8	3,5	3	2,7	5	3,0	2			
		1,0	2,5	2	2,2	4	2,5	2	4,7	1	
		1,2	2,0	3	1,8	4	2,0	1	4,5	1	
	1,5	0,6	5,0	4	5,0	6	5,0	4			
		0,8	4,0	4	3,5	6	3,0	3			
1,0		2,5	3	2,5	5	3,0	3	5,5	2		
1,2		2,4	4	2,0	5	2,2	2	5,0	2		
2,0	0,6	5,5	5	5,5	7	7,0	6				
	0,8	5,0	6	4,5	7	5,0	5				
	1,0	3,0	4	3,0	6	4,0	5	6,0	3		
	1,2	3,0	5	2,5	6	2,5	4	5,5	4		
3,0	0,6	8,0	10	7,5	10	9,5	9				
	0,8	5,5	7	5,0	9	6,0	7				
	1,0	4,0	6	4,0	9	4,5	6	6,5	6		
	1,2	4,0	8	3,0	8	3,5	6	6,0	6		
4,0	0,8	6,5	9	6,0	10	6,0	9				
	1,0	4,0	8	4,8	10	5,5	8	7,0	8		
	1,2	4,0	9	3,0	9	4,2	8	5,5	8		
	0,8	7,5	11	6,5	11	6,5	10				
5,0	1,0	5,5	10	5,0	11	5,0	10	8,0	10		
	1,2	4,5	11	4,0	11	4,5	10	6,0	10		
6,0	0,8	7,0	12	7,0	12	7,5	12				
	1,0	6,5	12	5,5	12	6,0	12	10	12		
	1,2	4,5	12	5,0	12	4,6	12	7,0	12		
0,6	0,6	5,0	4	6	7	5,5	6				
	0,8	5,5	9	3	4,5	8	4				
	1,0	3,5	8	4	4,0	9	4				
	1,2	3,5	9	4	3,0	9	4				
0,8	0,6	5,0	6	6	7,5	10	6				
	0,8	5,5	9	4	5,0	9	5				
	1,0	4,5	10	4	4,5	10	4				
	1,2	3,5	10	4	3,5	10	4				
1,0	0,6	8,0	9	8	7,5	10	7				
	0,8	7,0	11	5	7,0	12	5				
	1,0	5,0	11	5	5,0	11	4				
	1,2	4,0	11	5	4,0	11	4				
1,5	0,8	7,5	12	7	7,0	12	7				
	1,0	6,0	12	6	5,5	12	5				
	1,2	4,5	12	6	4,5	12	6				

GIN: 0349 308 420